

High Performance Turbine Meter

Sizes: 1 1/2", 2", 3", 4", 6", 8", and 10"

High Performance Turbine water meters offer some of the widest flow ranges of any turbine meters on the market.

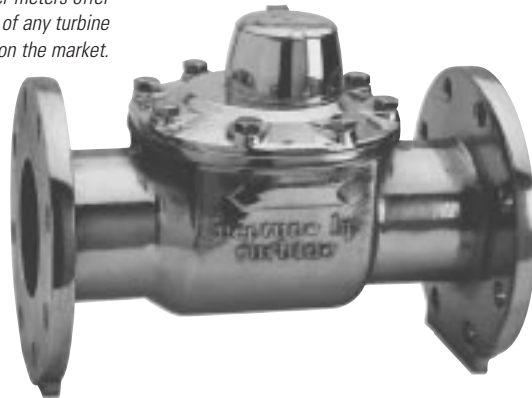

HP Turbine water meters offer some of the widest flow ranges of any turbine meters on the market. All HP Turbine water meters meet or exceed the latest performance and accuracy requirements of AWWA C701 and maximum continuous flow rates may be exceeded by as much as 25% for intermittent periods.

Application

The HP Turbine water meter is designed for applications where flow rates are consistently moderate to high.

Construction

Each HP Turbine consists of a rugged bronze maincase, an AWWA Class II turbine measuring element, and a roll-sealed register.

The bronze maincase is corrosion resistant, lightweight, and compact. Inlet and outlet connections are flanged. Strainers are available to prevent debris from entering the meter and to reduce the effects of uneven water flow due to upstream piping variations.

The Unitized Measuring Element (UME) allows for quick, easy, in-line interchangeability. Water volume is

measured accurately at all flows by a specially designed assembly. The hydrodynamically balanced thrust compensated rotor relieves pressure on the thrust bearings to minimize wear and provide sustained accuracy over an extended operating life. Direct coupling of the rotor to the gear train eliminates revenue loss due to slippage during fast starts and line surges. A calibration vane allows in-field calibration of the UME to lengthen service life and to ensure accurate registration.

The roll-sealed register eliminates leaking and fogging. A magnetic drive couples the register with the measuring element.

Warranty

Neptune provides a limited warranty with respect to its HP Turbine water meters for performance, materials, and workmanship.

When desired, owner maintenance is easily accomplished by in-line replacement of major components.

Systems Compatibility

Adaptability to all present and future systems for flexibility.

Key Features

- **Roll-Sealed Register**
 - Magnetic drive, low torque registration ensures accuracy
 - Impact-resistant register design with flat glass for readability
 - 1:1 ratio, low flow indicator identifies leaks
 - Bayonet mount allows in-line serviceability
 - Tamperproof seal pin deters theft
 - Date of manufacture, size, and model stamped on dial face
- **Cast Bronze Maincase**
 - Made from EnviroBrass®II
 - Compact design is lightweight and easy to handle
 - Sturdy, durable, corrosion resistant
 - Resists internal pressure stresses and external damage
 - Residual value
- **Turbine Measuring Element**
 - Excellent low flow sensitivity and wide flow ranges available at 98.5%–101.5% accuracy
 - Direct coupling of rotor to gear train prevents slippage and ensures accurate registration
 - Interchangeable measuring element allows for in-line service
 - Hydrodynamically balanced rotor
 - Reusable O-ring gasket on 3" –10" sizes

High Performance Turbine Meter

Sizes: 1 1/2", 2", 3", 4", 6", 8", and 10"

1 1/2" Accuracy

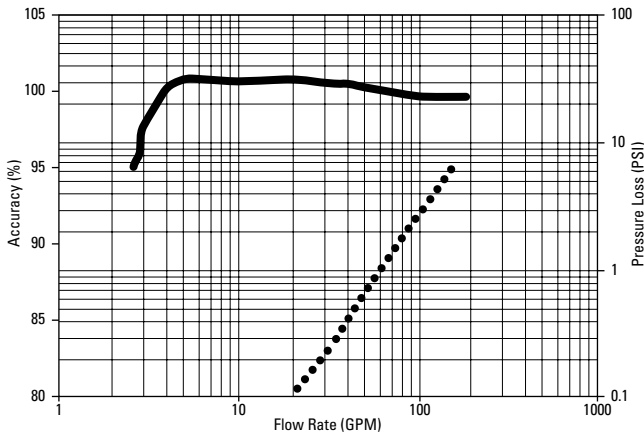

2" Accuracy

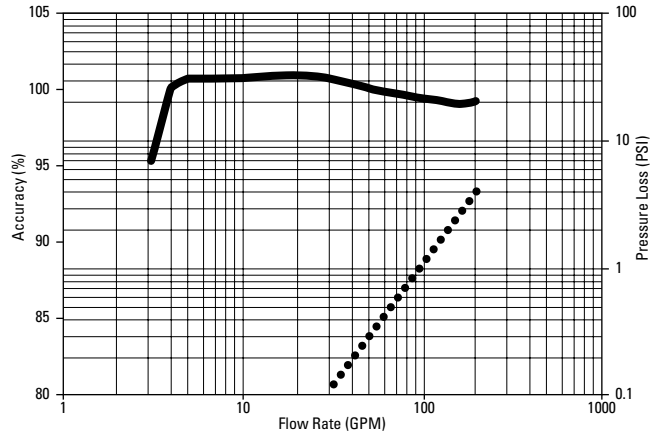

3" Accuracy

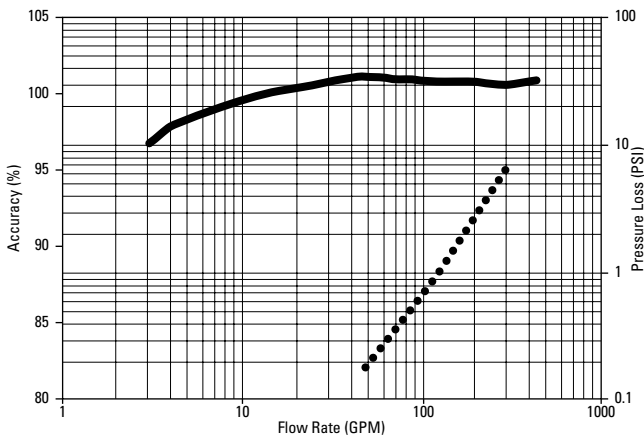

4" Accuracy

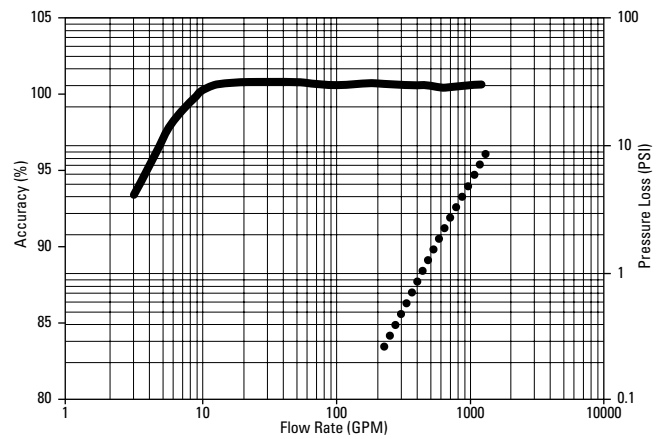

———— Accuracy
..... Head Loss

6" Accuracy

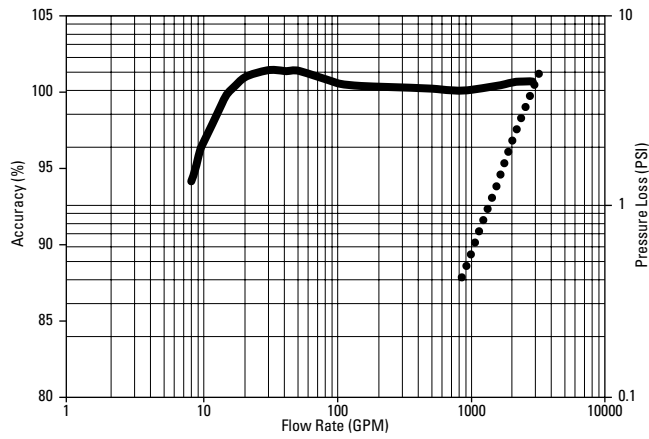

8" Accuracy

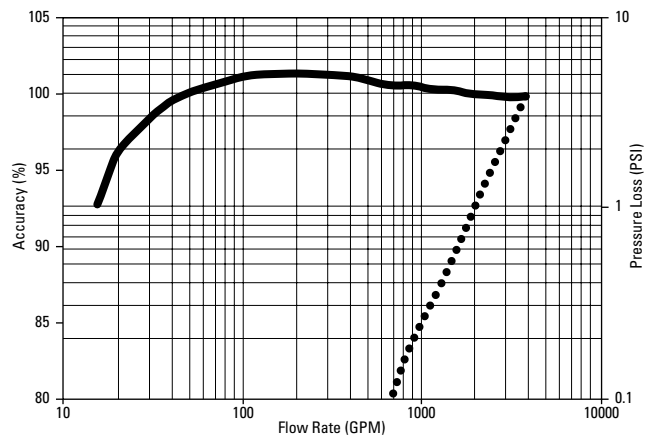

10" Accuracy

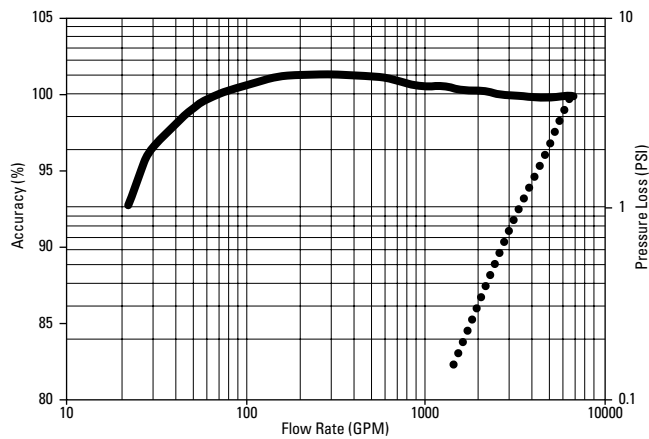

Accuracy
 Head Loss

These charts show typical meter performance. Individual results may vary.

Operating Characteristics

Meter Size	Normal Operating Range @100% Accuracy ($\pm 1.5\%$)	Maximum Intermittent Flow	AWWA Standard
1 1/2"	4 to 160 US gpm 0.91 to 36.3 m ³ /h	200 US gpm 45.4 m ³ /h	N/A
2"	4 to 200 US gpm 0.91 to 45.4 m ³ /h	250 US gpm 56.8 m ³ /h	4 to 160 US gpm 0.91 to 36.3 m ³ /h
3"	5 to 450 US gpm 1.14 to 102.2 m ³ /h	560 US gpm 127.2 m ³ /h	8 to 350 US gpm 1.8 to 79.5 m ³ /h
4"	10 to 1200 US gpm 2.27 to 272.5 m ³ /h	1500 US gpm 340.7 m ³ /h	15 to 630 US gpm 3.4 to 143.0 m ³ /h
6"	20 to 2500 US gpm 4.55 to 567.8 m ³ /h	3100 US gpm 704.1 m ³ /h	30 to 1400 US gpm 6.8 to 317.9 m ³ /h
8"	35 to 4000 US gpm 7.95 to 908.5 m ³ /h	5000 US gpm 1135.6 m ³ /h	50 to 2400 US gpm 11.4 to 545 m ³ /h
10"	50 to 6500 US gpm 11.36 to 1476.3 m ³ /h	8000 US gpm 1817 m ³ /h	75 to 3800 US gpm 17.0 to 863 m ³ /h

Registration

Registration (per sweep hand revolution)		1 1/2", 2", 3", 4"	6", 8", 10"
1,000	US Gallons	✓	✓
1,000	Imperial Gallons	✓	✓
100	US Gallons	✓	
100	Imperial Gallons	✓	
100	Cubic Feet		✓
10	Cubic Feet	✓	
10	Cubic Metres		✓
1	Cubic Metre	✓	
Register Capacity (6-wheel odometer)		1 1/2", 2", 3", 4"	6", 8", 10"
1,000,000,000	US Gallons		✓
1,000,000,000	Imperial Gallons		✓
100,000,000	US Gallons	✓	
100,000,000	Imperial Gallons	✓	
100,000,000	Cubic Feet		✓
10,000,000	Cubic Feet	✓	
10,000,000	Cubic Metres		✓
1,000,000	Cubic Metres	✓	

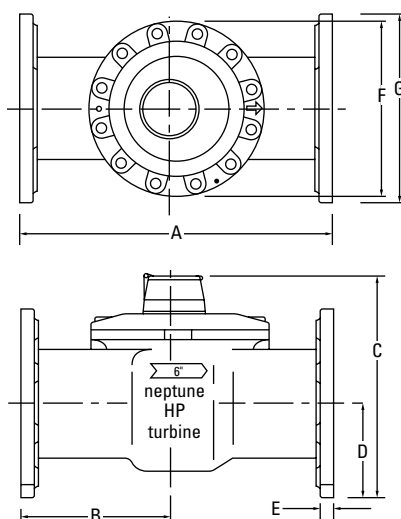

Dimensions

Meter Size	A in/mm	B in/mm	C in/mm	D in/mm	E in/mm	F in/mm	G in/mm	Weight lbs/kg
1 1/2"	10 (254)	6 1/2 (165)	7 1/8 (181)	1 3/4 (44)	3/4 (19)	4 1/2 (114)	5 3/8 (137)	19 (8.6)
2"	10 (254)	6 1/2 (165)	7 5/8 (194)	2 1/8 (54)	13/16 (21)	4 1/2 (114)	5 3/8 (137)	20 (9.1)
3"	12 (305)	6 (152)	10 (254)	3 3/4 (95)	5/8 (16)	6 1/4 (159)	7 1/2 (191)	40 (18.1)
4"	14 (356)	6 1/2 (165)	10 7/8 (276)	4 1/2 (114)	3/4 (19)	8 1/8 (206)	9 (229)	52 (23.6)
6"	18 (457)	8 5/8 (219)	13 (330)	5 1/2 (140)	1 (25)	10 1/4 (260)	11 (279)	115 (52.2)
8"	20 (508)	9 5/8 (244)	15 1/2 (394)	6 3/4 (171)	1 1/8 (29)	10 1/4 (260)	13 1/2 (343)	195 (88.4)
10"	26 (660)	12 5/8 (321)	15 1/2 (394)	8 (203)	1 1/4 (32)	10 1/4 (260)	16 (406)	275 (124.7)

Guaranteed Systems Compatibility

All HP Turbine water meters are guaranteed adaptable to our ARB®V, ProRead AutoDetect, TRICON®/S, TRICON/E3®, and Neptune meter reading systems without removing the meter from service.

Specifications

- Application: cold water measurement of flow in one direction
- Maximum operating pressure: 175 psi (1206 kPa)
- Maximum operating temperature: 80°F
- Register: direct reading, center sweep, roll-sealed, magnetic drive with low-flow indicator
- Measuring element: AWWA Class II Turbine, hydrodynamically balanced rotor

Options

- Sizes: 1 1/2", 2", 3", 4", 6", 8", 10"
- Units of measure: U.S. gallons, imperial gallons, cubic feet, cubic metres
- Register Types:
 - Direct reading: Bronze box and cover (standard)
 - Remote reading systems*: ARBV, ProRead AutoDetect, TRICON/S, TRICON/E3
 - Reclaim
- Companion flanges:
 - 1 1/2" and 2" (oval): bronze or cast iron
 - 3", 4", 6": bronze or cast iron
 - 8" and 10": cast iron
- Strainer:
 - 2"—6" bronze
 - 8"—10" bronze

* Consult factory for meter performance specifications when fitted with ARB.



www.neptunetg.com

Neptune Technology Group Inc.
1600 Alabama Highway 229
Tallahassee, AL 36078, USA
Tel: (800) 645-1892
Fax: (334) 283-7299

Neptune Technology Group Inc.
7275 West Credit Avenue
Mississauga, Ontario L5N 5M9, Canada
Tel: (905) 858-4211
Fax: (905) 858-0428

Neptune Technology Group Inc.
Via Gustavo Baz No. 29-C
Col. Naucalpan Centro
53000 Naucalpan, Estado de México
Tel: (525) 358-8737
Fax: (525) 576-1934

PS TURB 11/2-10 12.01
© Copyright 2001, Neptune Technology Group Inc.
ARB and TRICON are registered trademarks of Neptune Technology Group Inc.