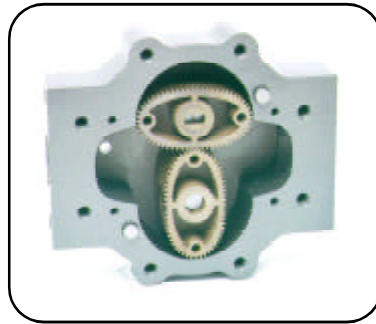

**Stealth Electronic Manual ZTM1010
Installation & Maintenance**

For Oval Gear Meter Models: TS10
TS15
TS20
TS30

including :

| | | | | | |
|------|--------------------------|--------|--------------------------|----------|--------------------------|
| CC56 | <input type="checkbox"/> | PIA | <input type="checkbox"/> | EDB 180 | <input type="checkbox"/> |
| PC58 | <input type="checkbox"/> | PCDT58 | <input type="checkbox"/> | PDB 180 | <input type="checkbox"/> |
| DU53 | <input type="checkbox"/> | PRT | <input type="checkbox"/> | PDMB 180 | <input type="checkbox"/> |
| ELNC | <input type="checkbox"/> | PAC | <input type="checkbox"/> | PMFC | <input type="checkbox"/> |

Meter Model No.: TS _____

FPP Meters and Our Principle of Operation

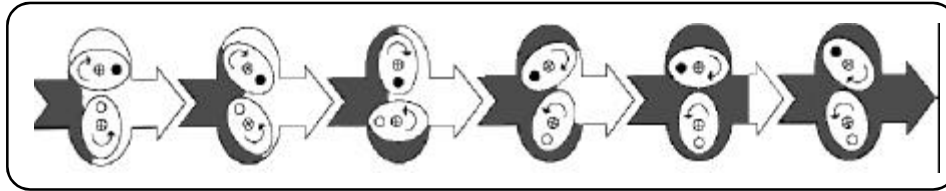

FPP Meters' Superior Meter Accuracy and Reliability Results from Two Close-Fitting Oval Gears within A Precision Measuring Chamber

About FPP Meters

FPP Meters, formerly Fluid Power Products, is now a tradename of Tuthill Transfer Systems. FPP was established in 1980. Since its inception, the company has been dedicated to manufacturing cost-effective high performance flow metering devices for petroleum, industrial, commercial, and municipal service.

Our facilities include computerized order entry and inventory control so that you are assured accurate and prompt deliveries. Furthermore, our production personnel ensure that each order, regardless of size, receives individual attention.

Constant attention to new product development and production design, our high standards of manufacture and final testing are the reasons why FPP Meters meet your most demanding requirements.

Our meters are used in batching, blending, process control and dispensing of liquid products in all liquid handling industries.

Principle of Operation

Elliptical-shaped rotors are used to accurately measure liquid flow by precisely sweeping a known volume of liquid through a close tolerance measuring chamber. The meshed rotors seal the inlet from the outlet flow, developing a small pressure differential. As the rotors rotate, they trap a precise quantity of liquid in the area between the rotor and the measuring chamber wall. The total quantity of flow for one rotation of the rotor pair is four times the volume trapped between the rotor and the measuring chamber wall. Close tolerance machining of the rotors and the measuring chamber means minimum slippage and high accuracy which is essentially unaffected by changes in viscosity. The rate of flow through the meter is proportional to the rotational speed of the rotors. Therefore, the meter output is directly proportional to the rate of flow. The output for Stealth meters can be either mechanical or

electronic. The output for mini oval gear meters is electronic.

In the mechanical meter, the output shaft drives a gear train that provides a registration in engineering units.

In the electronic version of the meter, magnets mounted in the rotors actuate a switch. Each switch closure represents a precise increment of volume. The switch output can then be used as an input to a variety of electronics including scaling counters, batch controllers, computers, analog converters, etc. The combination of accuracy, low cost and few moving parts makes the FPP Meters' mini oval gear meters a natural for your metering applications.

Fluid Compatibility

If in doubt about compatibility of a specified fluid, contact our manufacturing plant or see Chemical Compatibility Chart to check compatibility of chemicals to the wetted materials.

If You Have Any Questions About Installation or Operation, Please Consult the Factory Prior to Installation (888) 578-3258.

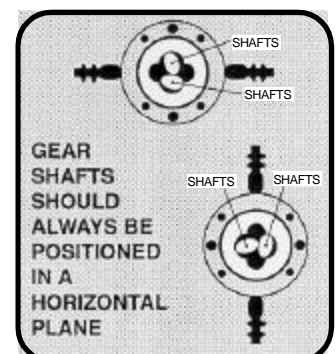

Installation & Operation



SAFETY INSTRUCTIONS

Make sure that all necessary safety precautions have been taken including proper clothing, personal safety equipment and fire safety equipment if required.

Before Start-up of Meter Make Certain:

- 1. The meter is properly mounted, secured and piped.**
- 2. All connections are tight.**
- 3. All bleed and drain valves are closed.**
- 4. Do NOT smoke near meter or use meter near an open flame when metering flammable fluids. Fire could result.**
- 5. This meter is not intended for use with fluids for human consumption.**

Install the Meter and Accessories in Compliance with All Applicable Local, State and Federal Construction, Electrical and Safety Codes.

Installation

Positive displacement meters are designed to operate full of liquid. The meter should be installed in a manner such that it remains full of liquid at all times.

Protective caps installed in each meter at the time of shipment should remain in the openings until you are ready to install in the piping system.

Prior to meter installation, the piping system should be flushed to remove all debris. Apply pipe compound to the male threads, to install the companion flanges.

The meter must be installed in the system free of pipe stress. Pipe stress can deform the meter chamber, resulting in loss of accuracy. The meter should always be supported by bolting to a platform. Never use the connecting pipe as the means of support.

When installing the meter consider future maintenance, and install in the best location available to facilitate future meter maintenance. The meter can be disassembled and serviced in place, and provisions for service should be considered during installation.

For the best accuracy, install the meter so that the gear shafts are positioned in a horizontal plane, rotating without the weight of the gear resting on the body or cover of the meter as shown on page 1. In critical installations block valves and by-pass lines are recommended. This allows the meter to be serviced without interruption of flow in critical process application.

Thermal relief valves are recommended and should be installed whenever it is possible to block the meter between two valves. Thermal pressures many times the operating pressure are possible with only a small rise in temperature.

It is recommended that a strainer be installed upstream of each meter to prevent damage from foreign matter, such as weld slag, pipe scale, etc.

Calibration means should be provided during installation. An easy means for diverting flow into a calibration vessel should be considered.

Hydraulic shock like thermal expansion can be harmful to meter components. Consideration should be given to designing pumping piping systems to eliminate hydraulic shock.

Operation

Fill the system slowly to avoid operation on air or vapor. This can be accomplished in the following manner:

1. Throttle the meter inlet valve, and allow to fill slowly by gravity.
2. Crack open the outlet valve, start the pump, then slowly crack open the inlet valve and fill the meter slowly before fully opening the inlet and outlet valves.

The meter is not designed to operate on air, but the design and materials of construction allow for operation on vapor for short periods of time without damage to the elliptical gears or meter internals.

Note: Over-speed and hammer caused by the presence of vapor in the system can cause internal damage to the meter.



SAFETY INSTRUCTIONS

The meter's non-shock Maximum Operating Pressure is indicated on the meter name plate. The meter should never be operated in excess of this pressure. Care should be taken to eliminate thermal and hydraulic shock pressures so that they do not exceed the meter's Maximum Working Pressure design.

Operating the meter in excess of its maximum design flow can cause excessive wear or premature failure. However, the meter can be calibrated to operate below the minimum design flow rate as indicated on the meter name plate if the flow remains constant, or the product is viscous.

Parts List for Electronic Meter Model TS10D

2003

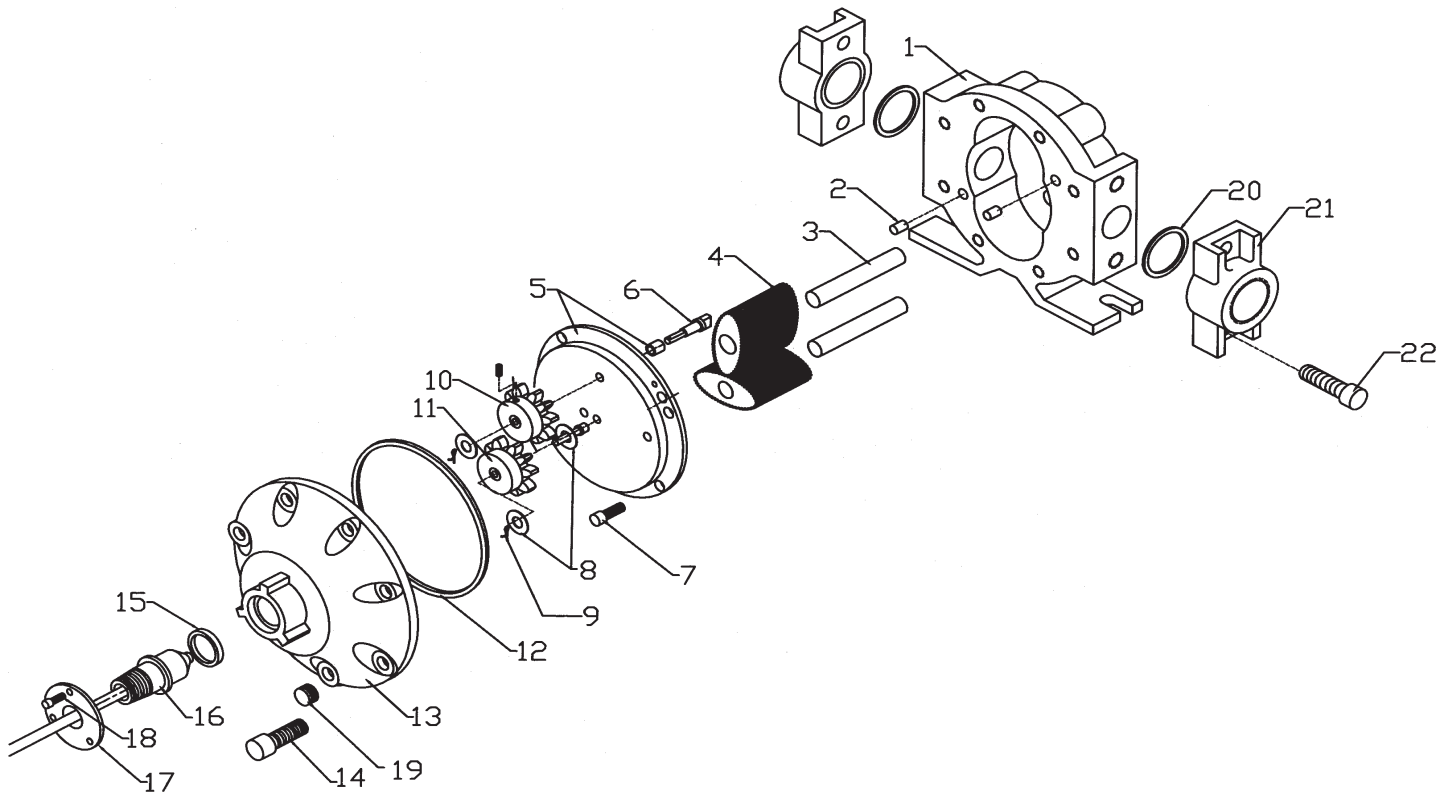

| Item | Qty. | Description | Part # | Item | Qty. | Description | Part # |
|------|------|---------------------|----------|------|------|------------------------|-----------|
| 1. | 1 | Meter Body 560 | MB9320 | 12. | 1 | O-Ring, Teflon | SL2157 |
| 2. | 2 | Dowel Pin | MS9021 | 13. | 1 | Cover, Front | CP9560 |
| 3. | 1 | Gear Post | MP9066-2 | 14. | 8 | 5/16 - 18 x 1" SS SHCS | FS9901 |
| 4. | 1 | Gear Set | GS560RT | 15. | 1 | O-Ring, Teflon | SL2212 |
| 5. | 1 | Gear Plate Assy | CP9853-1 | 16. | 1 | Reed Switch Assy | EL5569-RS |
| 6. | 1 | Drive Shaft | MP9043 | 17. | 1 | Retaining Plate | MP9061 |
| 7. | 1 | 10-32 x 3/8 SS SHCS | FS9651 | 18. | 3 | 8-32 x 3/8 SHCS | FS9515 |
| 8. | 3 | Washer | MP9053 | 19. | 1 | Plug | MS4019 |
| 9. | 2 | Cotter Pin | FS9210 | 20. | 2 | O-Ring, Teflon | SL2122 |
| 10. | 1 | Drive Gear | PL8101 | 21. | 2 | 1" Flange | MP9321 |
| 11. | 1 | Magnet Gear | PL8100 | 22. | 4 | 3/8 x 16 x 7/8 SS SHCS | FS2928 |

Torque Specifications

| Part # | Description | Torque | Tool |
|--------|-----------------------|-------------|------------|
| FS9830 | 1/4-20 X 3/4" SS SHCS | 65 in.lbs. | 3/16 Allen |
| FS9901 | 5/16-18 X 1" SS SHCS | 34 ft.lbs. | 1/4 Allen |
| FS9812 | 1/4-20 X 1/2" SS SHCS | 132 in.lbs. | 3/16 Allen |

* Recommended Spare Parts

Model RSFS Reed Switch Flow Sensor

The Reed Switch Flow Sensor consists of one set of contacts hermetically sealed in a glass tube. The atmosphere inside the glass body protects the contacts from the dirt and the corrosion of the outside world. The contacts are actuated by an external magnetic field provided by either a coil or permanent magnet. Reed switches are excellent choices when:

- Non-touch switching is required
- Contacts must be protected from contamination
- The environment must be protected from contact arcing (explosion prevention)

Contact Rating

- **Volts DC Max**
30 VDC
- **Amps DC Max**
0.01 A
- **Watts DC Max**
0.25 W
- **Initial Resistance**
1.0 Ω
- **Operating Temperature Range**
-40°F(-40°C) to +302°F(+150°C)
- **Wire Color / AWG**
Red / Black

- **Mini Oval Series**

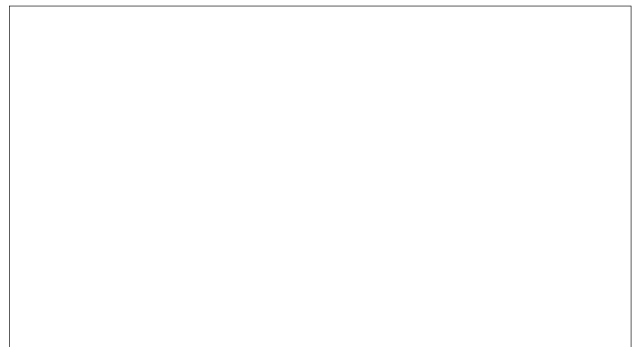

- **Stealth Series**

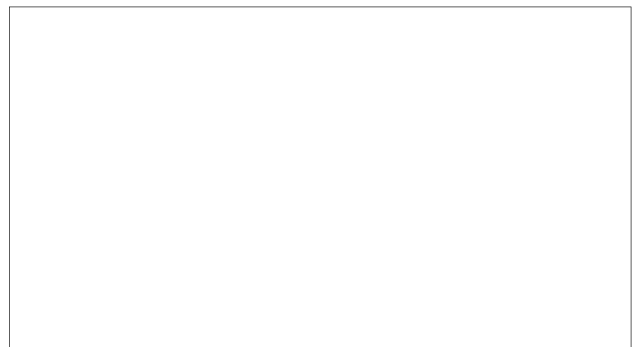

Model HEFS Hall Effect Flow Sensor

Features

- Digital current sinking output
- Bipolar operated with alternating north and south magnetic poles
- Operating speed: 0 to over 100 kHz
- Operating temperature range: -40° to 150°C / (-40° to 302° F)

Leadwire Color Code

Red Positive 4-28 VDC
 Black Negative (Signal Common)
 Blue, Clear or White Signal Output

Suggested Pull-up Resistor = 2 to 6 kΩ, 1/2 Watt

Pull-up Resistor (R1) The pull-up resistor provides the necessary voltage and current levels to guarantee a logic-1 output whenever the output transistor is in the “off” state. (Some controllers have the pull-up resistor available as a switch setting. Check the controllers manual for availability and proper switch settings.)

$$\text{Pull-up Resistor Size (k}\Omega\text{)} = \frac{V_{\text{supply}} \text{ (4-28 VDC)}}{\text{Desired Sink Current (0-20 mA)}}$$

| | |
|---------------------------|----------|
| Supply Voltage (VDC) | 4 to 28 |
| Supply Current (mA max.) | 13.5 |
| Output Type | Sink |
| Output Voltage (V) @ 20mA | .40 max. |
| Output Current (mA max.) | 20 |
| Leakage Current (μA max.) | 10 |
| Magnetics Type | Bipolar |

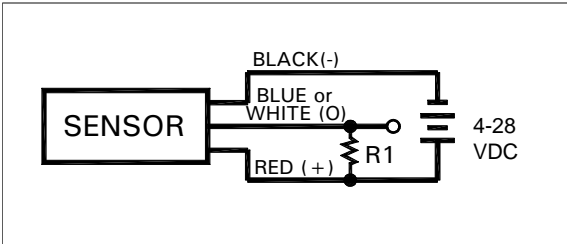

Please have the following information available when you make inquiries, order replacement parts, or schedule service:

Your meter's serial number: _____

Your meter's model number: _____

Your full service Distributor: _____

Your full service Distributor's phone number: _____

Warranty

Tuthill Transfer Systems ("Manufacturer") warrants to each buyer of its FPP Meters products (the "Buyer") for a period of 12 months from date of invoice or sales receipt, but in no event more than 18 months from date of manufacture, that goods of its manufacture ("Goods") will be free from defects of material and workmanship. Manufacturer's sole obligation under the foregoing warranties will be limited to either, at Manufacturers' option, replacing or repairing defective Goods (subject to limitations hereinafter provided) or refunding the purchase price for such Goods theretofore paid by the Buyer, and Buyer's exclusive remedy for breach of any such warranties will be enforcement of such obligations of Manufacturer. If Manufacturer so requests the return of the Goods, the Goods will be redelivered to Manufacturer in accordance with Manufacturer's instructions F.O.B. Factory. The remedies contained herein shall constitute the sole recourse of the Buyer against Manufacturer for breach of warranty. IN NO EVENT SHALL MANUFACTURER'S

LIABILITY ON ANY CLAIM FOR DAMAGES ARISING OUT OF THE MANUFACTURE SALE, DELIVERY OR USE OF THE GOODS EXCEED THE PURCHASE PRICE OF THE GOODS. The foregoing warranties will not extend to Goods subjected to misuse, neglect, accident or improper installation or maintenance, or which have been altered or repaired by anyone other than Manufacturer or its authorized representative. THE FOREGOING WARRANTIES ARE EXCLUSIVE AND IN LIEU OF ALL OTHER WARRANTIES OF MERCHANTABILITY, FITNESS FOR PURPOSE OF ANY OTHER TYPE, WHETHER EXPRESS OR IMPLIED. No person may vary the foregoing warranties and remedies except in writing signed by a duly authorized officer of Manufacturer. Warranties or remedies that differ from the foregoing shall not otherwise be binding on Manufacturer. The Buyer's acceptance of delivery of the Goods constitutes acceptance of the foregoing warranties and remedies, and all conditions and limitations thereof.



TUTHILL
Transfer Systems

48513 Highway 51 North P.O. Box 400
Tickfaw, Louisiana USA 70466
Tel 504 542-5200 Fax 504 542-7394

www.tuthill.com