



***GREAT PLAINS INDUSTRIES, INC.***

---

## Deluxe Liquid Crystal Display

Instruction manual

---



Display to suit GPI GM Series Positive Displacement Flowmeters

---

---

# To the owner

---

Thank you for purchasing a GPI Deluxe Liquid Crystal Display. Please take a few minutes to read through this manual before installing and operating your display. If you have any problems with the display, refer to the maintenance and trouble shooting sections of this manual.

This manual contains connection and operating instructions for the GPI Deluxe Liquid Crystal Display. If you need further assistance, contact your local GPI representative or contact GPI by telephone or fax.

The Deluxe LC Display is available on

specific GM4, GM7, GM5, GM10, GM40 and GM50 series models. It is also available as an accessory so it can be used as a remote mounted display for any GM Series meter model supplied without a display. e.g. GM1, GM2 etc.

---

## Important Information

---



### **PLEASE READ THIS INFORMATION CAREFULLY BEFORE USE!**

Before use, confirm the fluid to be used is compatible with the meter (refer to the GPI fluid compatibility chart), or consult your local GPI representative for advice.

Ensure that the inlet/outlet pipework is correctly aligned. Stress due to misalignment will damage the liquid meter.

Shock pressure should not exceed the nominal pressure on the name plate. Excess pressure may damage the meter.

Keep solvents away from keys and liquid crystal display.

Do not clean electronic register with organic solvents

Amplifier, meter and other external equipment should only be installed and maintained by qualified personnel. Operators should have suitable instructions and training as to the systems operation. Electrical power should only be applied when the system has been tested and certified for use.

Check all connections for tightness.

### **FOR USE IN HAZARDOUS LOCATIONS!**

Observe Certificate of Conformity and Operating Instructions.

Replacement battery must take place outside of the hazardous area. This is essential.

Avoid electrostatic charge in both, the installation of the equipment and during operation.

Only clean with a conductive damp cloth.

For automatic operation in hazardous locations only use approved amplifiers.

EEx ia IIC T6 - Specification for explosion proof apparatus

PTB Nr. EX-93.C.4033X - Certificate of Conformity Number

# Description



The current leakage quantity always depends on the previous measuring operation.

## Normal Operation

The quantity of liquid passing through the meter will be measured and displayed (partial quantity counter). No additional devices are necessary.

it is necessary to use 2 valves.

- Step 1:** Both valves are open
- Step 2:** One valve closes (precise measuring operations starts).
- Step 3:** The second valve closes.

## Factory Calibration

Factory calibration is not protected and can be changed by the user. Calibration constant is entered prior to shipment;

- GM4 = 0089
- GM5 = 0123
- GM7 = 0192
- GM10 = 0278
- GM40 = 0689
- GM50 = 1500

## Automatic Operation (Presettable Batch Controller)

A preset quantity can be transferred in automatic operation. In order to control valves, the motor of the pump and/or other similar devices by the meter, an amplifier according to NAMUR signals is required. The amplifier transforms the control signal from the meter into relay signals.

1 amplifier with 2 output signals, 2 valves and a regulating valve are required.

## Leakage Quantity (Time Lag of the Valves)

If the "OFF" signal (close) is displayed, there will be a time lag before the valve will be closed. During this time an unknown quantity of liquid will pass through the meter. This quantity is called leakage quantity. The leakage quantity is measured by the meter during each measuring operation and it is taken into account when starting the next measuring operation.

## For transferring foaming liquids or if shock pressures are too high;

The meter enables a measuring operation of a liquid in 3 steps. For this

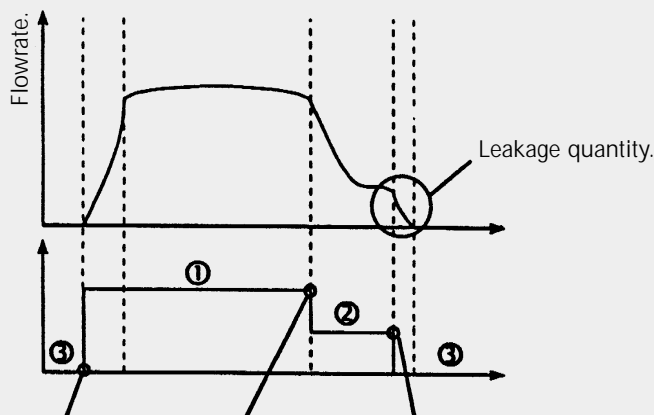

START was pressed, measuring operation is running. Both valves are open.

The first valve is closed, PRESIGNAL disappears from the display.

The second valve is closed, ON changes to OFF (main signal).

A regulating valve enables fine tuning of the flowrate.

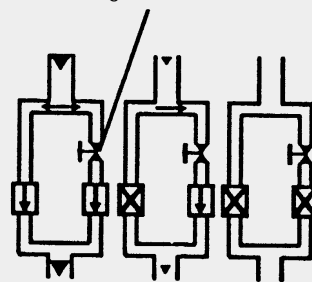

① Both valves are open.

② Both valves are closed.

---

---

# Specifications

---



## GPI Deluxe Liquid Crystal Display

<b>Measuring Unit:</b>	Can be set to Litres, US Gallons or Imperial Gallons.  Imperial Gallons = "IMP GAL" = 4.5460 Litres. US Gallons = "US GAL" = 3.7854 Litres.
<b>Calibration Constant:</b>	10 different constants can be recorded. Each constant can be set by keys within the range of 0.0000 to 0.9999. Only the 4 points after the decimal point are displayed.
<b>Partial Quantity Counter:</b>	7-digit display;   999999.9 Litres maximum. 999999.9 Gallons maximum. No overflow indication (the counter starts again at zero). Resettable to 0 by special combination of keys only.
<b>Totaliser:</b>	7-digit display without decimal point;   9999999 Litres maximum. 9999999 Gallons maximum.
<b>Automatic Range of Presetting:</b> (Relative Automatic Operation)	To be set to 99.99, 999.9 or 9999 Litres/Gallons.
<b>Preset Quantity:</b> (Relative Automatic Operation)	10 different preset quantities can be set. The preset quantity can be within the predetermined range (Automatic range of Presetting).
<b>Presignal Quantity:</b> (Relative Automatic Operation)	The set presignal quantity is valid for all preset quantities. The presignal quantity can be set between 0.0 and 9.9 Litres/Gallons.
<b>Cycle Counter:</b> (Relative Automatic Operation)	No overflow indication (the counter starts again at zero). If the preset quantity is changed, this counter will reset to 0 automatically.

# Change of battery

In order to change the battery you have to remove the electronic display unit from the meter. Replacement of the battery must take place outside of the hazardous area (if applicable).

Remove the 4 slotted screws and carefully take off the electronic display unit. (Refer to Fig. 2).

Unplug pulse from connection block 2 and replace battery (Refer to Fig. 3).

**NOTE:** The battery has to be replaced within one minute. If the battery has not been replaced within one minute;

- \* All calibration constants will reset to 0.05000 and,
- \* All preset quantities will reset to "0" and,
- \* All counters will reset to "0".



If the battery has not been replaced within one minute, remove the battery again and short circuit PIN 8 and PIN 9 on the connection block ST2 for at least 3 minutes in order to ensure a safe start-up of the electronics. A new battery may then be fitted.

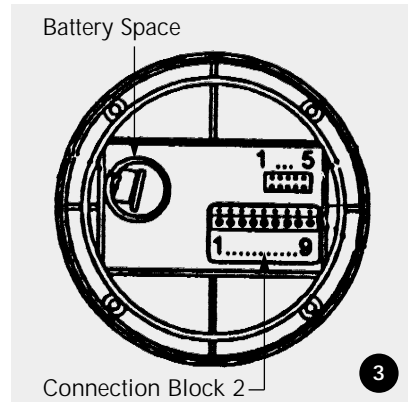
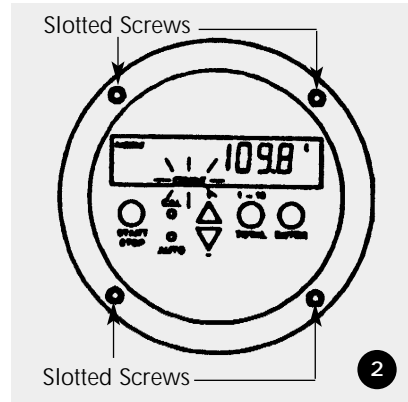

# LC Display View

Register 1...10 When setting Calibration Constant or Preset Quantity

Cycle Counter 0...999 In Automatic Operation

Set Unit - Set Unit is flashing; Mode "Select Measuring Unit" is set

Normal Operation

Automatic Operation - "AUTO" is flashing; Mode "Select Automatic Range of Presetting" is set

Main Signal On/Off

"TOT" - The Total Quantity is displayed

"CAL" is flashing - Mode; "Selection and setting of a Calibration Constant" is set.

"CAL" is static - display of the set Calibration Constant.

"BAT" is flashing, 1-3 weeks of operating time are left under normal conditions.

"BAT" static - no further action possible, all data maintained.

"COUNT" is flashing as soon as the sensor receives impulses

Presignal On/Off. If presignal is set to 0, "PRESIGNAL" will disappear from the display

# Meter keys view

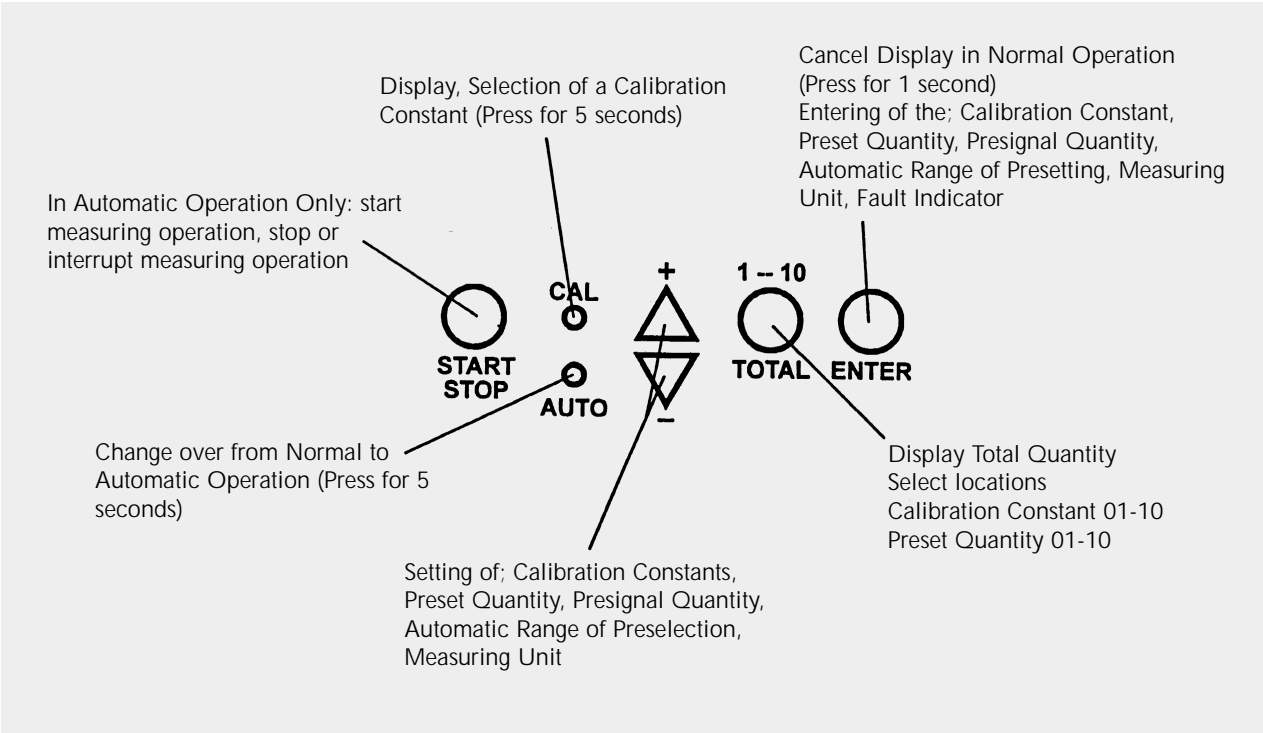

# Operation view

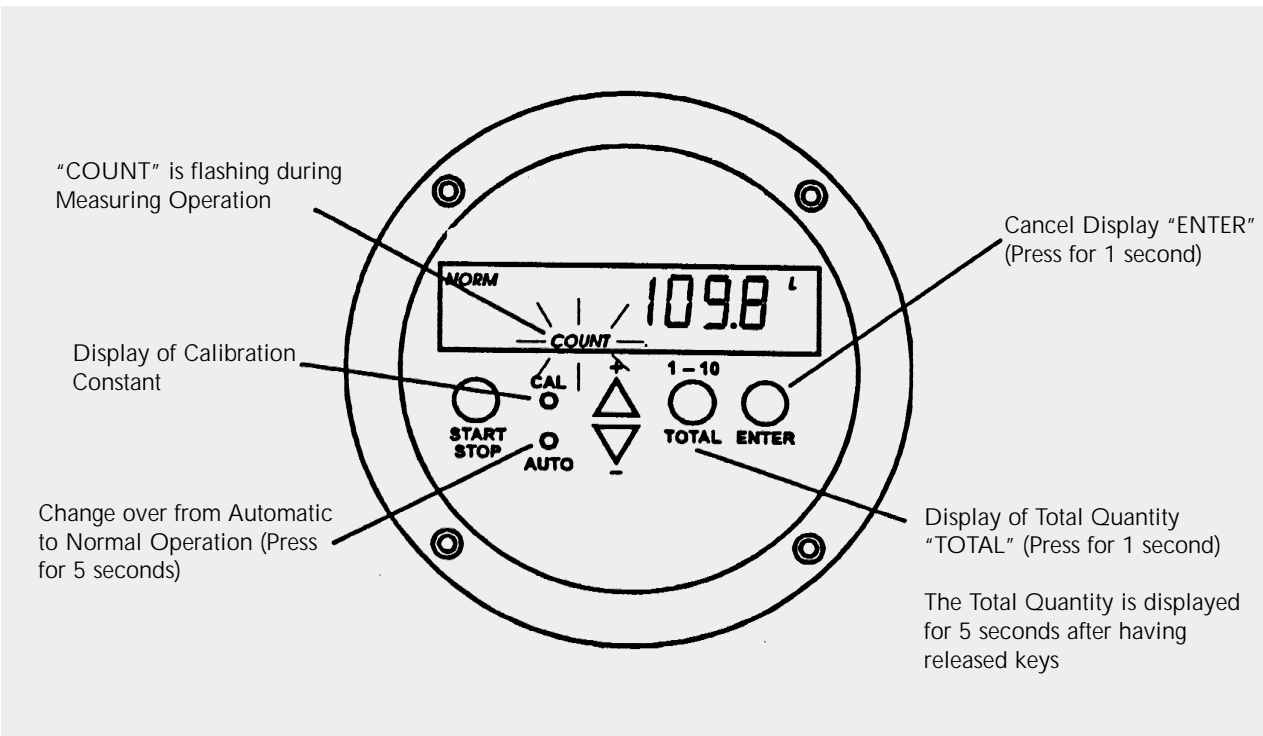

# Normal operation mode

To perform the following procedures in normal operation mode refer to:

**Cancel Total Quantity (Fig. 4)**

**Display Flowrate (Fig. 5)**

**Cancel Total Quantity**  
 Keep "TOTAL" pressed until total quantity is displayed. Then press simultaneously the keys "+" and "-", keep all three keys pressed until display is cancelled. (Approximately 5 seconds).

**Display of Flowrate**  
 Press simultaneously "TOTAL" and "ENTER". Flowrate is displayed as long as these keys are pressed.

# Operation

Display is flashing; Change respective setting by "+"; "-" or "1-10".

The setting will be confirmed by pressing "ENTER".

"COUNT" is flashing during measuring operation

Display of Calibration Constant

Start and interrupt measuring operation

Change over from Normal to Automatic Operation (Press for 5 seconds)

Display of Total Quantity "TOTAL"

Press for 1 second - Partial Quantity is displayed

Press for 5 seconds - Total Quantity is displayed

The Quantities are displayed for 5 seconds after having released the keys

Change Preset Quantity, Select Locations

# Automatic operation mode

To perform the following procedures in automatic operation mode refer to;

Cancel Total Quantity (Only possible in normal operation mode)

Display Flowrate (Fig. 6)

**Display Flowrate**  
Press simultaneously "TOTAL" and "ENTER". Flowrate is displayed as long as these keys are pressed.

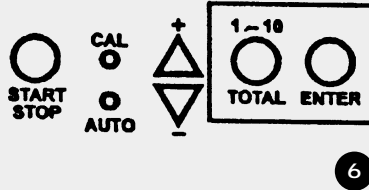

# Fill quantity operation

Automatic Operation Mode;

Before pressing the keys

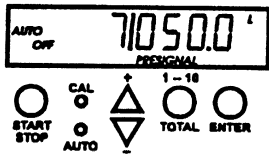

At the first press of "+" or "-" the display starts flashing

After pressing the keys

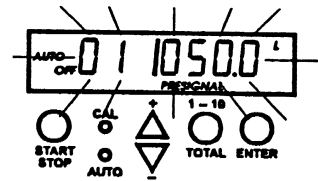

Preset quantity is changed by pressing "+" or "-"; depress for speed input

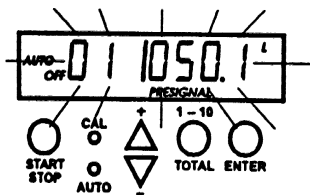

A change of the preset quantity will reset the cycle counter to 0

A register can be selected by pressing the (TOTAL) key 1--10

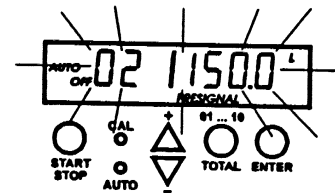

The display preset quantity will be confirmed by pressing the key "ENTER". The meter switches automatically over to setting of the presignal quantity

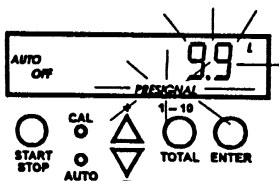

Set precise quantity by "+" or "-"  
A change of the presignal quantity will not reset the cycle counter.

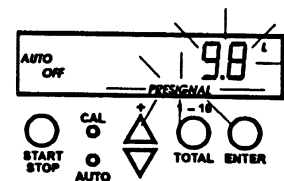

The display presignal quantity will be confirmed by pressing the key "ENTER". The meter switches automatically over to the preset quantity.



# Fill quantity operation



Start filling cycle by the key "START/STOP";

- Filling Cycle:**
- "OFF" changes to "ON"
  - Cycle counter increases
  - "COUNT" is flashing during measuring
  - Preset quantity is counted to "0"
  - "ON" changes to "OFF"
  - The leakage quantity is measured for 2 seconds
  - The set preset quantity is displayed again

# Fault indicator

Fault indicator is flashing ! "FFFF" Press the key "ENTER"	
FAULT	CLEAR FAULT
The presignal quantity plus the automatically measured leakage quantity are higher than the total filling quantity	Increase total filling quantity or reduce presignal quantity or use higher speed valves (reduce leakage quantity)
Fault indicator is static! "FFFF"	<p>Press the key "ENTER" - remaining filling quantity is displayed.</p> <p>Continue measuring operation of the remaining filling quantity by pressing the key "START/STOP"</p> <p style="text-align: center;">or</p> <p>Press again "ENTER" - back to the preselection quantity</p>
No flow has been measured for 5 seconds	<p>Refill tank or container with liquid</p> <p>Check amplifier, pump and valves for function</p> <p>Rotors do not turn (due to dirt, wear etc)</p> <p>Pulse is defective</p>

# Calibration constant

Selection or changes to the calibration constant can be effected in the normal or automatic operation mode.

Briefly pressing "+" or "-" changes the calibration by 0.0001. Depress for speed input

Press "CAL" for more than 5 seconds



The display constant will be set by pressing the key "ENTER". The meter switches automatically back to the previous mode. (Normal or automatic operation)

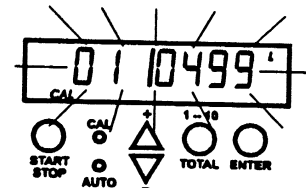
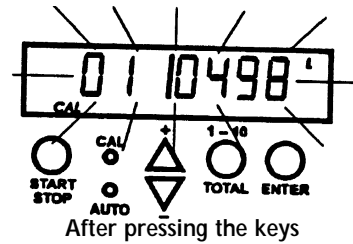

# Select measuring unit

If the measuring unit is changed, all recorded calibration constants will be converted into the new unit. All recorded preset quantities will reset to "0".

If the automatic range of presetting is changed, all recorded preset quantities will reset to "0"

This mode can be set in normal and automatic operation mode;

Press "CAL". Then press simultaneously the keys "+" and "-". Keep all three keys pressed for more than 5 seconds.

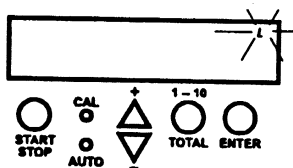

Select the desired measuring unit by pressing the key "+" and "-".

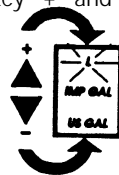

The displayed measuring unit will be confirmed by pressing the key "ENTER". The meter switches automatically over to the selection of the automatic range of presetting.

Select the desired range by pressing the key "+" or "-".

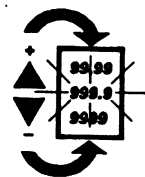

The display range will be confirmed by pressing the key "ENTER". The meter switches automatically back to the previous mode. (Normal or automatic operation).

# Connections diagram

Back view of the LCD electronic

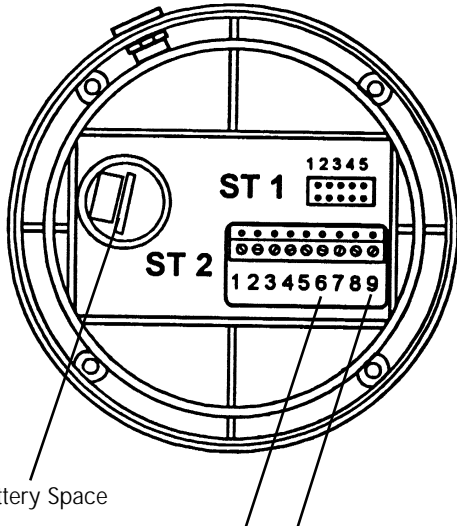

Battery Space

Connection to Meter Pulse Output

ST2 Connection Block 2

- 2/1 No Function
- 2/2 No Function
- 2/3 Presignal (VS+)  
Outlet to amplifier
- 2/4 On/Off (Main Signal) (HS+)  
Outlet to amplifier
- 2/5 No Function
- 2/6 External Pulse  
Input for reed switch (1)  
Transmission by +3 Volts Pulses  
(ST 2/9)
- 2/7 External Start/Stop  
(See example of application 2)
- 2/8 Minus (GND)
- 2/9 + 3 Volts Reed Switch (2)



Note: The battery has to be removed when using the extended battery. (Refer to diagram above).

# Amplifier diagram

Amplifier with 1 output signal for installation into a switch board.

2 amplifiers with 1 output signal for installation into a switch board.

Amplifier with 2 output signals for installation into a switch board.

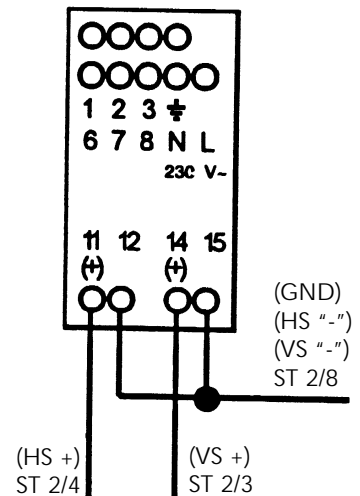
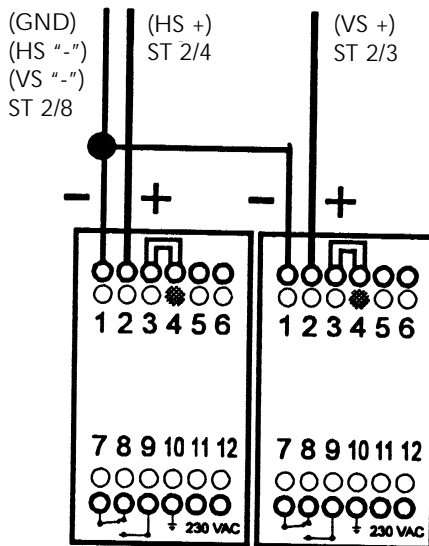
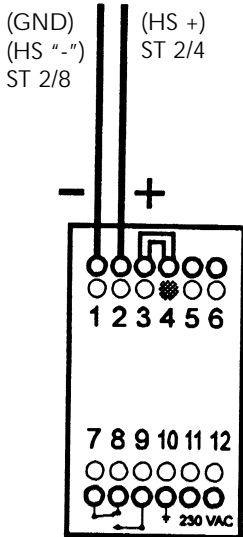

# Example applications

Connections and diagrams are typical. Actual installations may vary from those shown in this booklet.

1. Electronic display mounted on liquid meter; amplifier with 1 output signal for installation into a switchboard for controlling 1 valve. Refer Fig. 7.

Necessary Cable Connections;

- A. Control cable from meter to amplifier.
- B. Voltage cable from amplifier to meter.

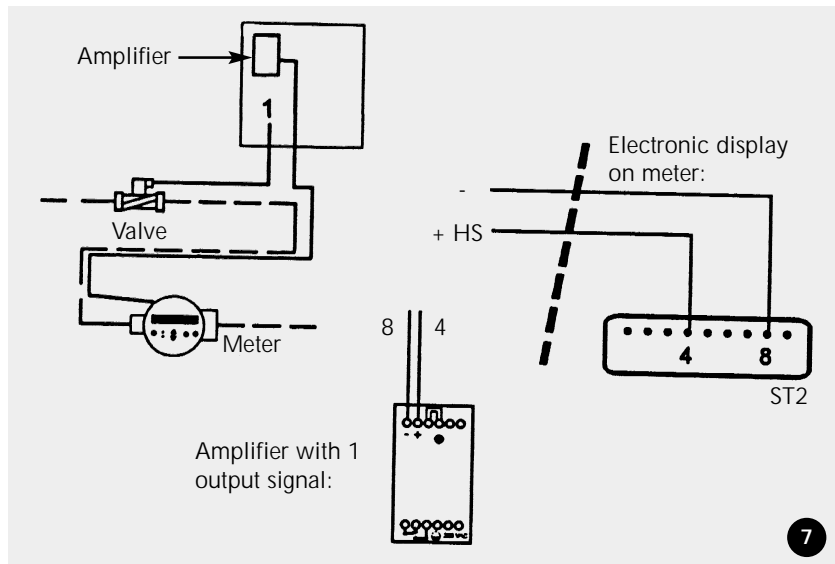

2. Electronic display mounted on liquid meter; amplifier with 1 output signal for installation into a switchboard for controlling 1 valve; external Start/Stop device. Refer Fig. 8.

Necessary Cable Connections;

- A. Control cable from LC-Display to amplifier.
- B. Control cable from external Start/Stop to meter.

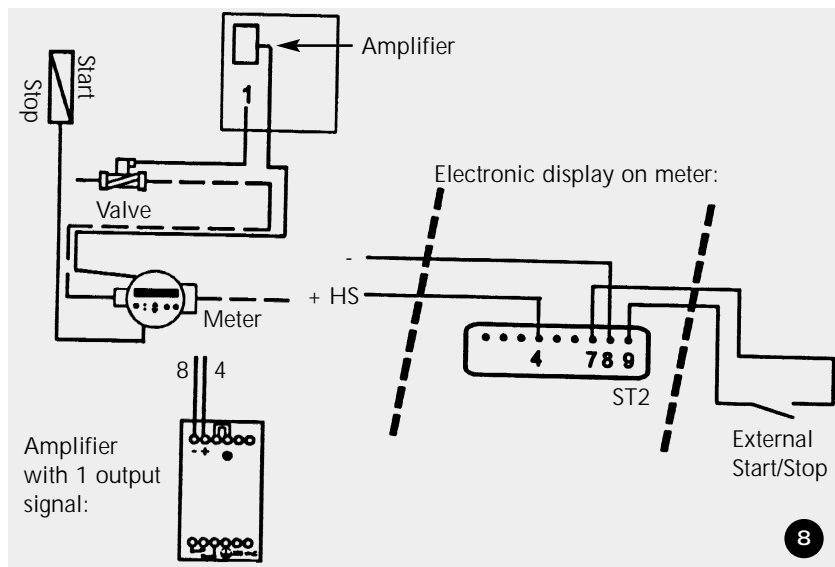

Supply voltage cable from amplifier to valve. The cable has to be run from PIN 3 to 7. (In this case the presignal cannot be used).

# Example applications

3. Electronic display mounted onto quick action tap; amplifier with 1 output signal for installation into a switchboard controlling 1 valve. Liquid meter without display unit. Refer Fig. 9.

Necessary Cable Connections;

- A. Pulse cable from LC-Display to quick action tap (max. 12m).
- B. Control cable from quick action tap to amplifier.
- C. Supply voltage cable from amplifier to valve.

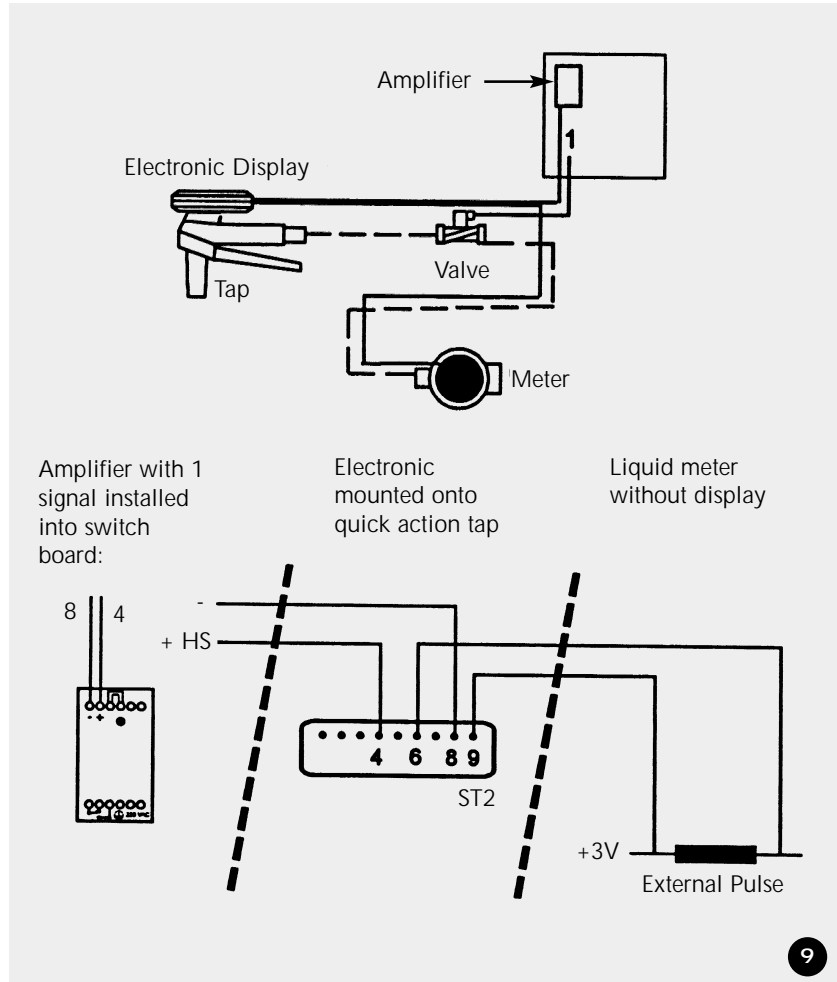

# Summary tables

## Summary Table for Normal Operation:

If the battery has not been removed within one minute, all registered constants will be reset to **0500**.

Factory Calibration on location 01 with calibration fluid			M4=0089, M5=0123, M7=0192, M10=0278, M40=0689, M50=1500
Location No.		Location No.	
01	Factory Set (See Above)	06	
02		07	
03		08	
04		09	
05		10	

## Summary Table for Automatic Operation

PRESIGNAL							
Calibration Constant 01 to 10				Filling Quantity 01 to 10			
Location No.		Location No.		Location No.		Location No.	
01		06		01		06	
02		07		02		07	
03		08		03		08	
04		09		04		09	
05		10		05		10	

# Warranty

---

## Great Plains Industries, Inc. Limited Warranty Policy

Great Plains Industries, Inc., 5252 East 36th Street North, Wichita, Kansas USA 67220-3205, hereby provides a limited one year warranty against defects in material and workmanship on all products manufactured by Great Plains Industries, Inc. This warranty shall extend to the purchaser of this product and to any person to whom such product is transferred during the warranty period.

The warranty period shall begin on the date of the original new equipment purchase. Warrantor's obligation hereunder shall be limited to repairing defective workmanship or replacing or repairing any defective part or parts. This warranty shall not apply if:

- a.) The product has been altered or modified outside the warrantor's duly appointed representative;
- b.) The product has been subjected to neglect, misuse, abuse or damage or has been installed or operated other than in accordance with the manufacturer's operating instructions.

To make a claim against this warranty, notice of claim must be given in writing to the company at its address below no later than 30 days after the expiration of the warranty period. Such notice shall identify the defect in the product. The company shall, within 14 days of receipt of such notice, notify the customer to either send the product, transportation prepaid, to the company at its office in Wichita, Kansas, or to a duly authorized service center. The company shall perform all obligations imposed on it by the terms of this warranty within 60 days of receipt of the defective product.

**GREAT PLAINS INDUSTRIES, INC. EXCLUDES LIABILITY UNDER THIS WARRANTY FOR DIRECT, INDIRECT, INCIDENTAL AND CONSEQUENTIAL DAMAGES INCURRED IN THE USE OR LOSS OF USE IF THE PRODUCT WARRANTED HEREUNDER.**

The company herewith expressly disclaims any warranty of merchantability or fitness for any particular purpose other than for which it was designed.

This warranty gives you specific rights and you may also have other rights which vary from U.S. state to U.S. state.

NOTE: In compliance with MAGNUSON MOSS CONSUMER WARRANTY ACT - Part 702 (governs the resale availability of the warranty terms).



5252 East 36th Street North  
Wichita, KS USA 67220-3205  
TEL: 316-686-7361  
FAX: 316-686-6746

---